

Struttura portante: in legno massello e multistrato monoscocca con molleggio garantito da cinghie elastiche ad alta componente di caucciù.

Preparazione della struttura, versione HI-TEX: in poliuretano espanso a quote differenziate ad alta densità e resilienza. Ulteriore rivestimento della struttura in microfibra "Hi-tex", imbottitura di ultima generazione, ad alto fattore di comfort, certificata OEKO-TEX STANDARD 100, ignifuga, 100% riciclabile.

Preparazione della struttura, versione MEMOSOFF: in poliuretano espanso a quote differenziate ad alta densità e resilienza. Layer superiore di seduta in poliuretano espanso speciale MEMOSOFF. Ulteriore rivestimento della struttura in microfibra "Hi-tex", accoppiata con vellutino.

Schienali mobili: realizzati con 3 differenti parti in poliuretano sagomate a controllo numerico, a densità differenziata, ad alta resilienza. All'interno dell'assemblaggio delle imbottiture è predisposta una lastra d'acciaio che equilibra il manufatto. Ulteriore rivestimento dello schienale con fibra di poliestere termolegata, accoppiata con vellutino. Alla base dello schienale è predisposto, unito al rivestimento, uno speciale elastomero di derivazione nautica che permette l'ancoraggio per attrito.

Braccioli mobili: realizzati in poliuretano a densità differenziata. All'interno dell'assemblaggio delle imbottiture è predisposta una lastra d'acciaio che equilibra il manufatto. Ulteriore rivestimento del bracciolo con fibra di poliestere termolegata accoppiata con vellutino. Alla base del bracciolo è predisposto, unito al rivestimento, uno speciale elastomero di derivazione nautica che permette l'ancoraggio per attrito.

Cuscini schienale: totalmente imbottiti in microfibra "Hi-tex" canalizzata di ultima generazione.

Sfoderabilità: rivestimento sfoderabile in tutte le versioni (tessuto e nabuk).

Basamento: speciali piedi arretrati in ABS con gomma antiscivolo che permettono il posizionamento delle composizioni divani senza ganci o connessioni fra gli elementi.

Structure: in solid wood and plywood, monocoque with high natural rubber content elastic strap webbing.

Preparation of the seat HI-TEX version: in high resilience variable-density polyurethane foam. Outer covering with "Hi-tex" microfiber, innovative padding, certificated OEKO-TEX STANDARD 100, fire resistant, 100% recyclable.

Preparation of the seat, MEMOSOFF version: in high resilience variable-density polyurethane foam. Upper layer with special polyurethane foam MEMOSOFF. Outer covering with "Hi-TEX" microfiber laminated to technical fiber.

Movable backrest: made with 3 different high resilience polyurethane parts shaped under numerical control. Backrest construction has inside a metal plate. Additional cover in heat-bonded polyester fiber laminated to technical fiber. Thanks to a special nautical elastomer fixed with the cover, backrest attach on the base.

Movable armrest: in variable-density polyurethane foam. Armrest construction has inside a metal plate. An additional cover in heat-bonded polyester fiber laminated to technical fiber. Thanks to a special nautical elastomer fixed with the cover, armrest attach on the base.

Back cushion: channeled "Hi-tex", a last generation microfiber.

Covers: completely removable in all version (fabric and leather)

Base: specials half-hidden ABS feet, non-slip rubber allows to join sofa without junction hook.

FILIPH

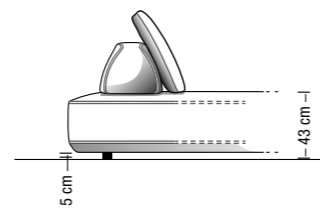
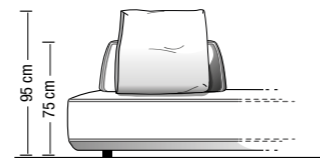

FILIPH HS 45

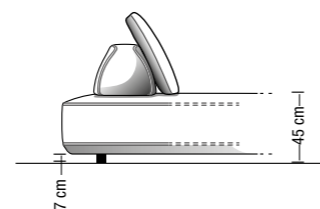
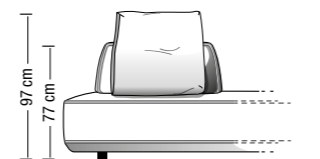

Altezza cuscino orizzontale
Horizontal backrest cushion

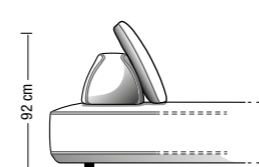

Altezza cuscino poggiatesta
Backrest cushion with headrest

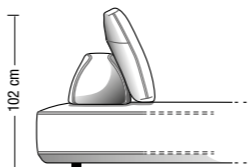

Sono disponibili misure speciali su richiesta. I disegni a catalogo sono da considerarsi suggerimenti di configurazione: schienali e cuscini sono elementi liberamente abbinabili.

Custom-made elements are available on request. Drawings are configuration suggestions: backrests and cushions are freely combinable elements.

Divano da 125 cm
Sofa 125 cm

FL125

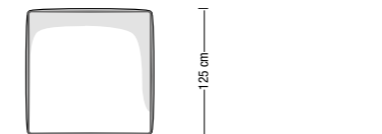
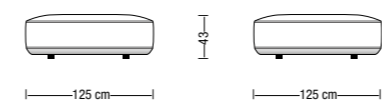

Esempio di disposizione di schienale mobile
Movable backrest placement example

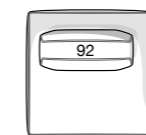

Divano da 175 cm
Sofa 175 cm

FL175

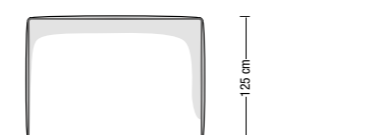
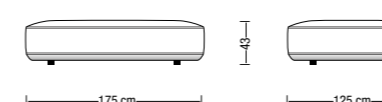

Esempi di disposizione di schienali mobili
Movable backrests placement examples

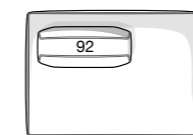
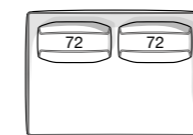

Divano da 195 cm
Sofa 195 cm

FL195

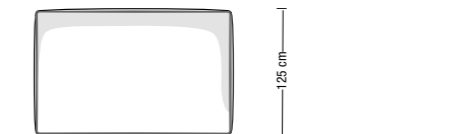
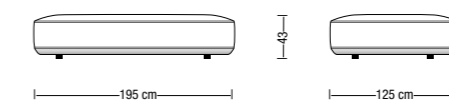

Esempi di disposizione di schienali mobili
Movable backrests placement examples

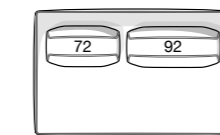

Divano da 225 cm
Sofa 225 cm

FL225



Esempio di disposizione di schienali mobili
Movable backrests placement example



Divano da 255 cm
Sofa 255 cm

FL255

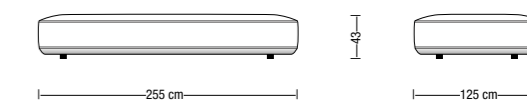

Esempi di disposizione di schienali mobili
Movable backrests placement examples

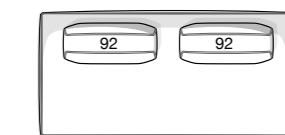
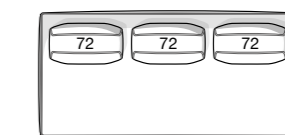

Divano da 285 cm
Sofa 285 cm

FL285

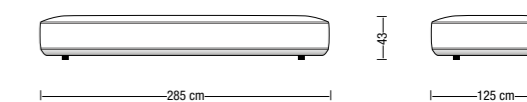

Esempi di disposizione di schienali mobili
Movable backrests placement examples

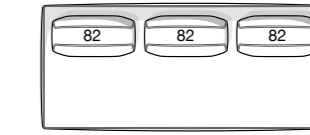

Pouf / Divano da 125x85 cm
Ottoman / Sofa 125x85 cm

FL85

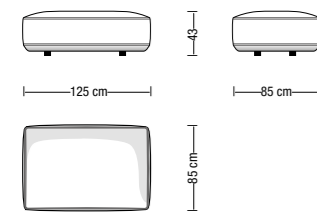

Esempio di disposizione di schienale mobile
Movable backrest placement example



Divano da 110x110 cm
Sofa 110x110 cm

FL110X

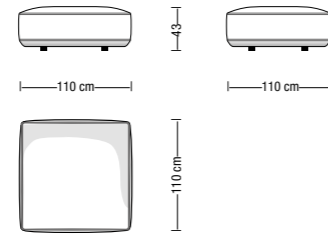

Esempio di disposizione di schienale mobile
Movable backrest placement example



Divano da 175x110 cm
Sofa 175x110 cm

FL175X

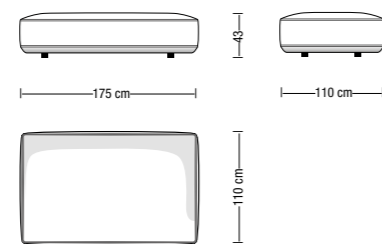

Esempi di disposizione di schienali mobili
Movable backrests placement examples

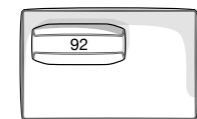
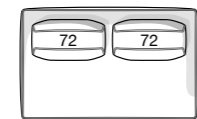

Divano da 195x110 cm
Sofa 195x110 cm

FL195X

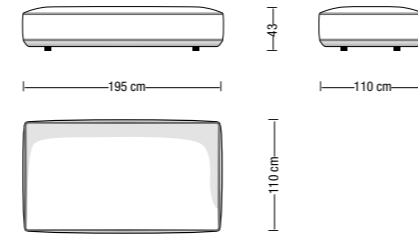

Esempi di disposizione di schienali mobili
Movable backrests placement examples

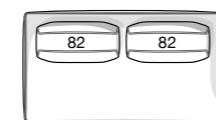
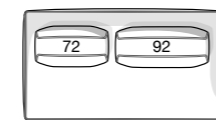

Divano da 225x110 cm
Sofa 225x110 cm

FL225X

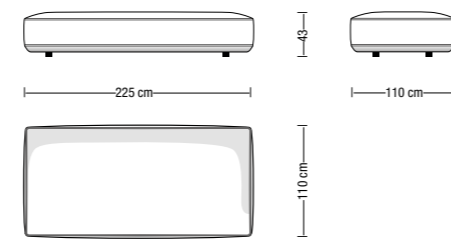

Esempio di disposizione di schienali mobili
Movable backrests placement example

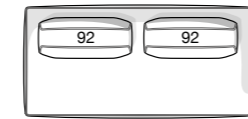

Divano da 255x110 cm
Sofa 255x110 cm

FL255X

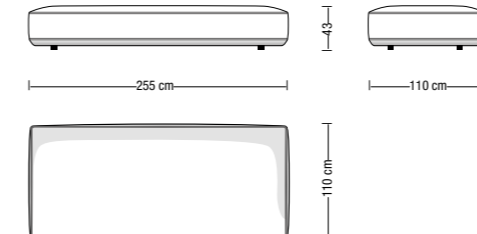

Esempi di disposizione di schienali mobili
Movable backrests placement examples

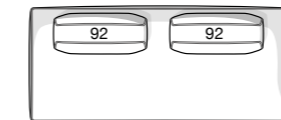

Pouf / Divano da 110x85 cm
Ottoman / Sofa 110x85 cm

FL85X

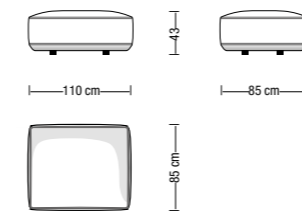

Esempio di disposizione di schienale mobile
Movable backrest placement example



Divano Pentagonale
Pentagonal Sofa

FL5

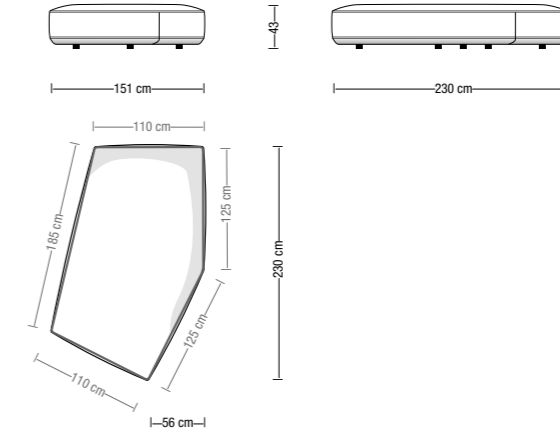

Configurazioni divano pentagonale ed esempi di disposizioni schienale mobile
Pentagonal sofa layouts and movable backrest placement example

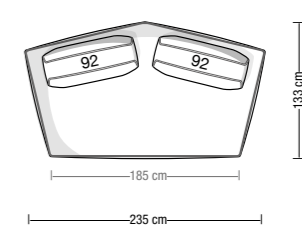
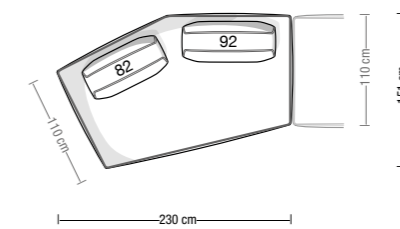
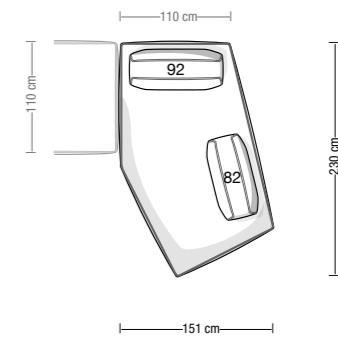
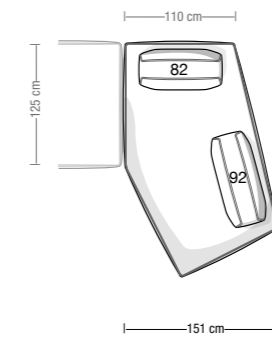

Schienali mobili
Movable backrests

Schienale mobile 72
Movable backrest 72

FLM72

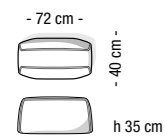

Schienale mobile 82
Movable backrest 82

FLM82

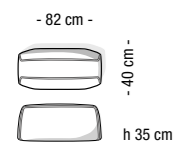

Schienale mobile 92
Movable backrest 92

FLM92

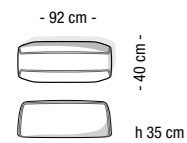

Schienale mobile 122V
Movable backrest 122V

FLM122V

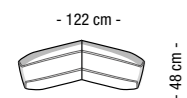

Cuscini - Schienali
Backrest cushions

Cuscino schienale poggiatesta
Backrest cushion headrest

FLSPT

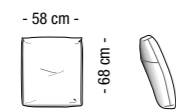

Cuscino schienale orizzontale
Horizontal backrest

FLSO

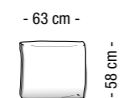

Cuscino schienale verticale
Vertical backrest

FLSV

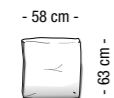

Cuscino schienale verticale con rullo
Vertical backrest with headrest bolster

FLSVR

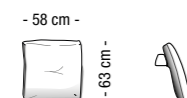

Poggiareni
Lumbar rest

FLP

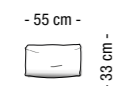

Accessori ergonomici
Ergonomics accessories

Bracciolo mobile
Movable armrest

FLB

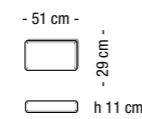

Rullo indipendente per schienale verticale
Headrest bolster for vertical cushion

FLR

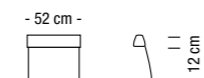

Rullo abbinabile con FLSV
Bolster matchable with FLSV

Pouf abbinabili a Filiph
Ottomans matchable with Filiph

Pouf Love 63 cm
Ottoman Love 63 cm

LV63P

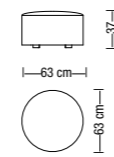

Pouf Love 83 cm
Ottoman Love 83 cm

LV83P

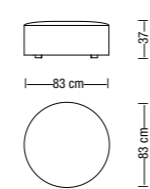

Pouf Filiph Air da 63x53 cm
Ottoman Filiph Air 63x53 cm

FA63X53

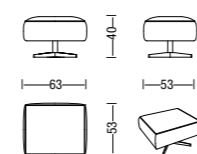

Composizioni suggerite
Compositions suggested

C1 da 300x175 cm

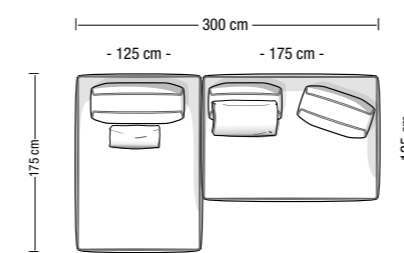

C3 da 225x125 cm

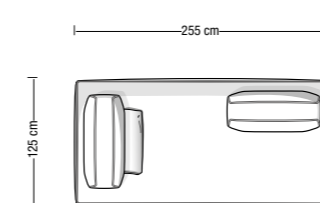

C5 da 320x225 cm

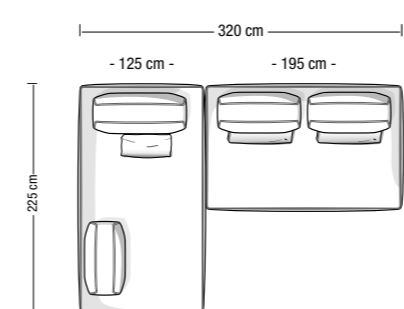

C7 da 225X125 cm + 225X125 cm

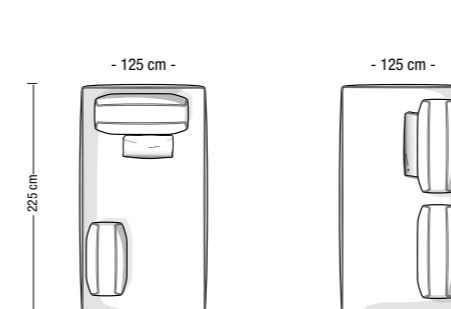

C2 da 320x195 cm

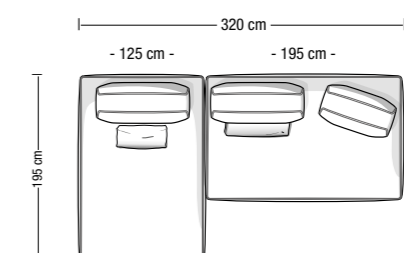

C4 da 285x210 cm

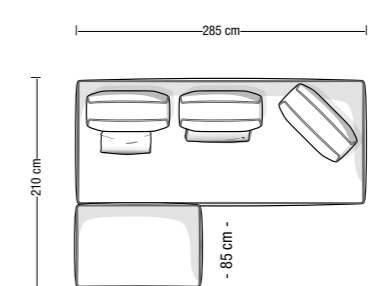

C6 da 350x225 cm

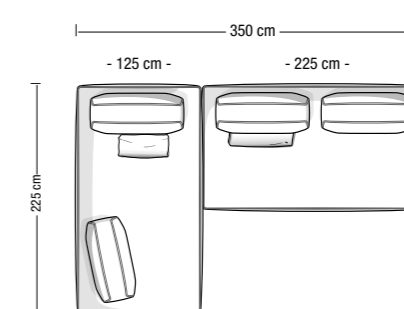

C8 da 350x320 cm

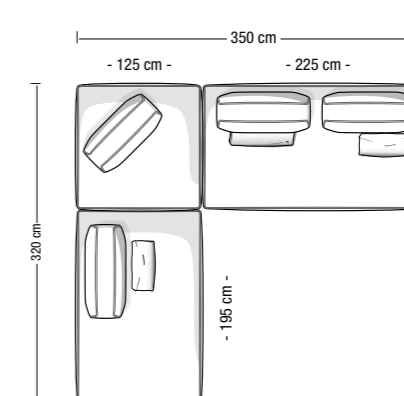

Composizioni suggerite con elementi a profondità 110cm
 Compositions suggested with 110cm depth elements

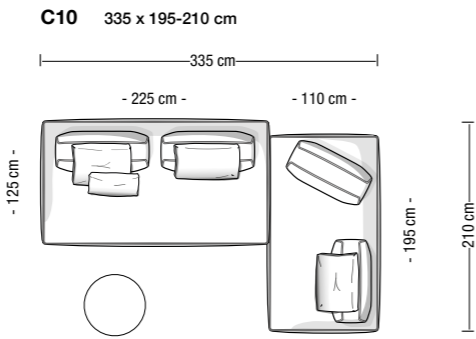
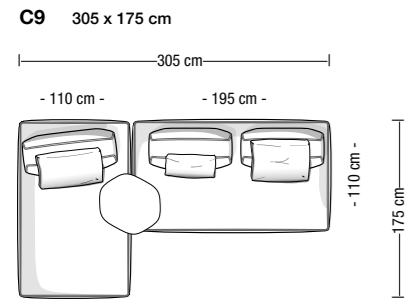

Composizioni suggerite con elemento pentagonale
 Compositions suggested with pentagonal sofa

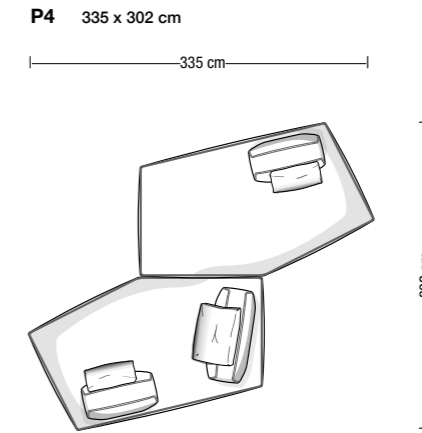
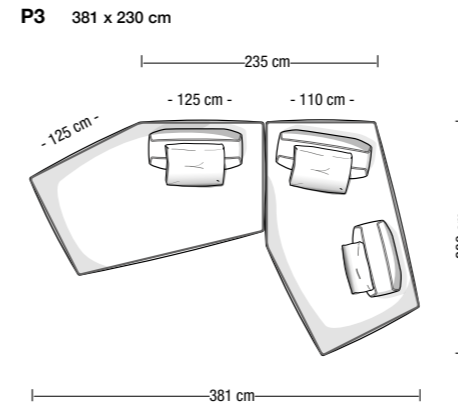

Composizioni suggerite con elemento pentagonale
 Compositions suggested with pentagonal sofa

