

Struttura portante: in legno massello e multistrato monoscocca con inserti strutturali in acciaio, molleggio garantito da cinghie elastiche ad alta componente di caucciù.

Preparazione della struttura: in poliuretano espanso a quote differenziate ad alta densità e resilienza. Ulteriore rivestimento della struttura con fibra di poliestere termolegata di forte spessore, accoppiata con vellutino.

Cuscinatura: imbottitura cuscino di seduta in poliuretano espanso a densità differenziate. Layer superiore di seduta in poliuretano espanso speciale ad alta traspirabilità MEMOSOFF. Rivestimento in ovatta di poliestere siliconata ad alto spessore, accoppiata con tela di cotone bianca. In alternativa, su richiesta: imbottitura cuscino in "Memofill" canalizzato (particelle di poliuretano viscoelastico termosensibile e innovativa microfibr "Hi-tex") con inserto centrale in poliuretano ad alta resilienza. Ulteriore rivestimento del cuscino con fibra di poliestere termolegata accoppiata con tela di cotone bianca.

Cuscini schienale: in piuma d'oca canalizzata certificata "Assopiuma etichetta Oro".

Cuscini ornamentali: in piuma d'oca canalizzata certificata "Assopiuma".

Sfoderabilità: rivestimento sfoderabile nella versione in tessuto, fisso nella versione in pelle.

La sfoderabilità della base è attuabile previo smontaggio dle basamento. I poggiatesta e le strutture metalliche dei braccioli sono fisse. Cuscini seduta, rullo bracciolo e schienale sempre sfoderabili.

Basamenti: piedi a disegno speciale in metallo pressofuso e tubolare di cornice in alluminio estruso, disponibile nelle versioni: Peltro, Alluminio spazzolato lucido, Nichel nero con tubolare rivestito in pelle.

Poggiatesta opzionali: schienalini indipendenti e spostabili in acciaio rivestito in pelle o in Tecnonabuk, disponibili nei colori in collezione.

Braccioli opzionali: braccioli indipendenti e spostabili in acciaio rivestito in pelle o in Tecnonabuk, disponibili nei colori in collezione. Rullo staccabile con imbottitura in poliuretano espanso e rivestimento in ovatta di poliestere siliconata ad alto spessore, accoppiata con vellutino.

Finiture basamento
Metal base finish



Peltro
Pewter



Alluminio
Aluminium



Nichel nero + pelle
Black nickel + leather

Structure: in solid wood and plywood, monocoque, with steel reinforcements. High natural rubber content elastic strap webbing.

Preparation of the seat: in high resilience variable-density polyurethane foam. Out covering with heat-bonded polyester fiber laminated to technical fiber.

Seat cushion: in high resilience variable-density polyurethane foam with MEMOSOFF (breathable polyurethane foam), covered with a high depth polyester silicon fiber heat-bonded to white cotton canvas.

In alternative, on request: "Memofill" quilt (heat-sensitive foam and innovative microfiber "Hi-tex" mixed) with high resilience polyurethane foam central insert with out covering with heat-bonded polyester fiber laminated to cotton.

Backrest cushions: channeled goose down, certified "Assopiuma", gold label.

Ornamental cushion: channeled goose down, certified "Assopiuma".

Covers: are completely removable in fabric version and fixed in leather version. The structure fabric cover is removable only after the metal base disassembling. Movable armrest and headrest are always fixed. Seat cushion, armrest bolster and backrest cushion covers are completely removable.

Base: special design die-cast metal feet and aluminium extruded tubular frame, available in these finishes: painted Peltro, Polished brushed aluminum or black Nichel feet with leather covered tubular frame.

Optional headrest: movable metal backrest covered with leather or Tecnonabuk as available colors.

Optional armrest: movable metal armrest covered with leather or Tecnonabuk as available colors. Bolster (removable) in high resilience polyurethane foam, covered with a polyester silicon fiber heat-bonded

BYRON

Dimensioni e altezze di seduta con base profondità 102 cm
Sitting depth and hight with base 102 cm

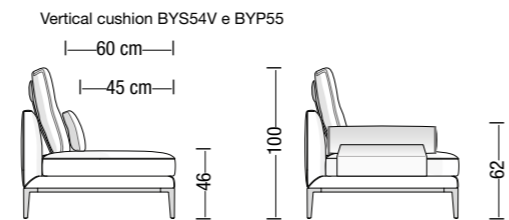
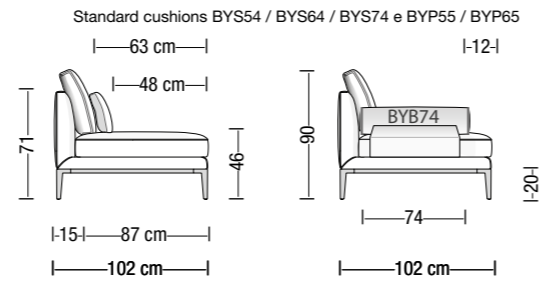

Dimensioni e altezze di seduta con base profondità 92 cm
Sitting depth and hight with base 92 cm

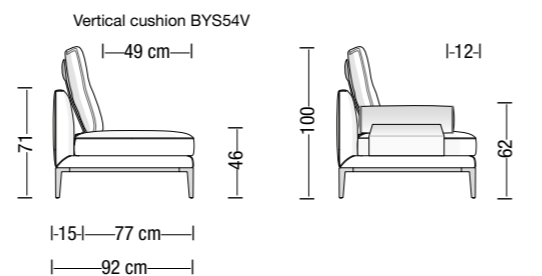
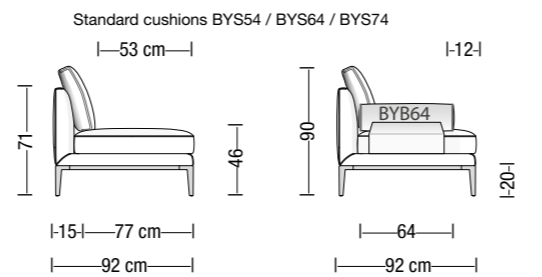

Divani con braccioli a rullo, profondità 92 cm
Sofas with roll armrests, 92 cm depth

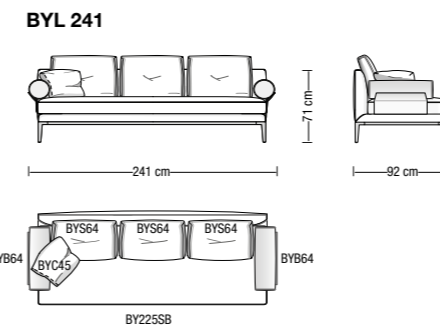
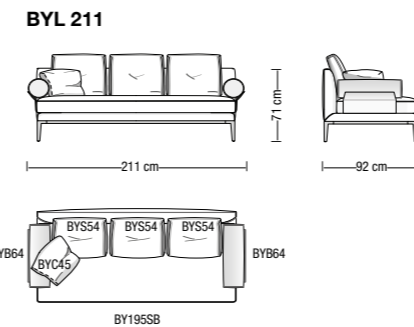
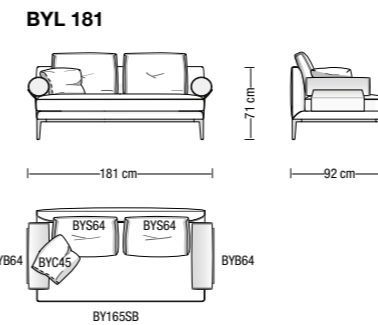

Disposizione alternativa schienali
Alternative backrest cushions layout

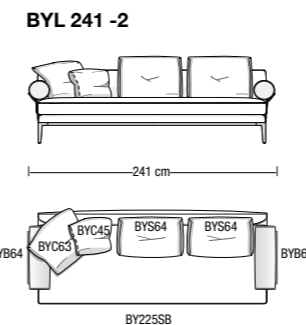

Divani con 1 bracciolo a rullo, profondità 92 cm
Sofas with 1 roll armrest, 92 cm depth

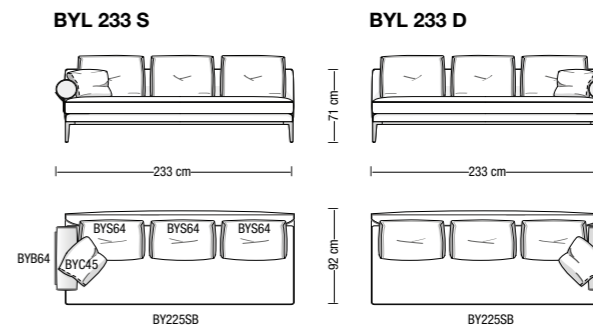
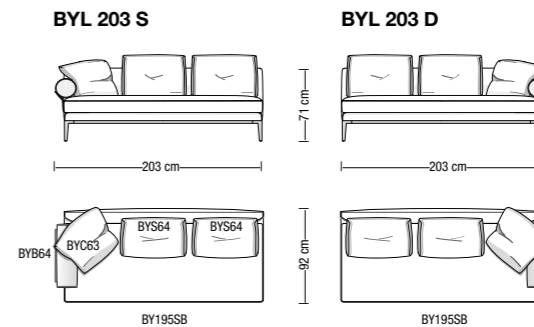
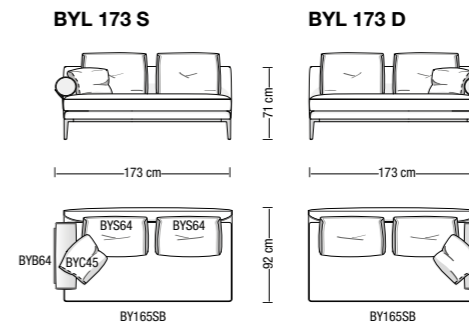

Elementi centrali, profondità 92 cm
Central elements, 92 cm depth

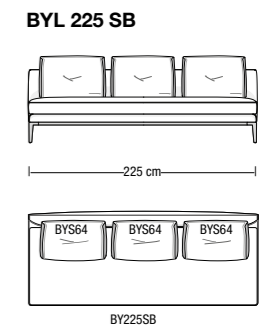
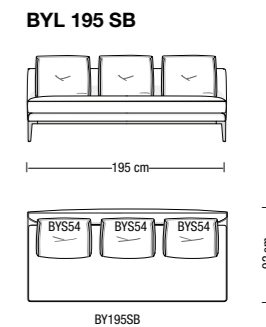
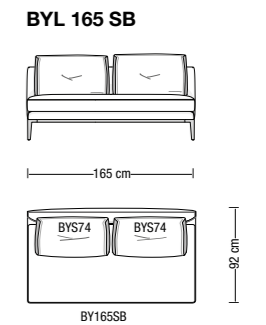

Divani con braccioli, profondità 92 cm
Sofas with armrests, 92 cm depth

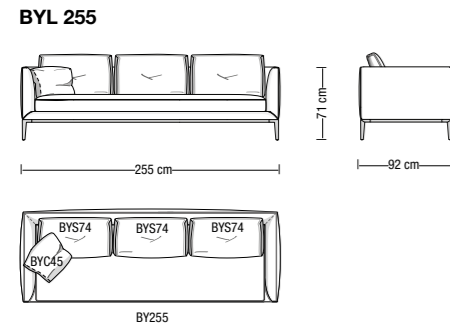
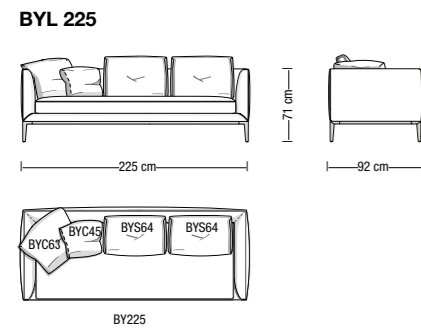
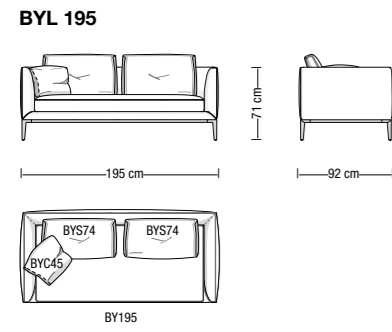

Disposizione alternativa schienali
Alternative backrest cushions layout

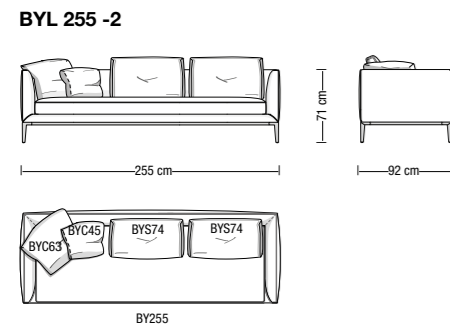

Divani con 1 bracciolo, profondità 92 cm
Sofas with 1 armrest, 92 cm depth

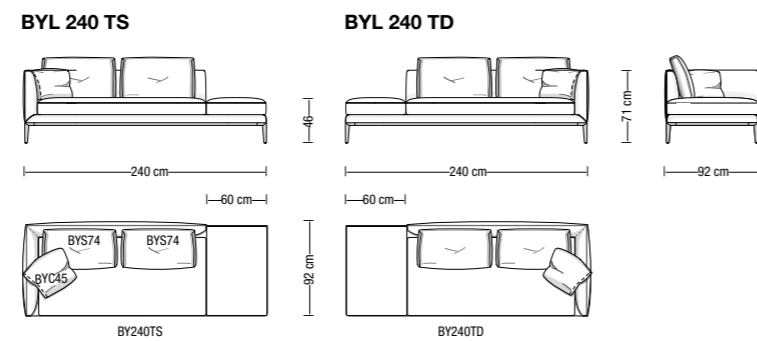
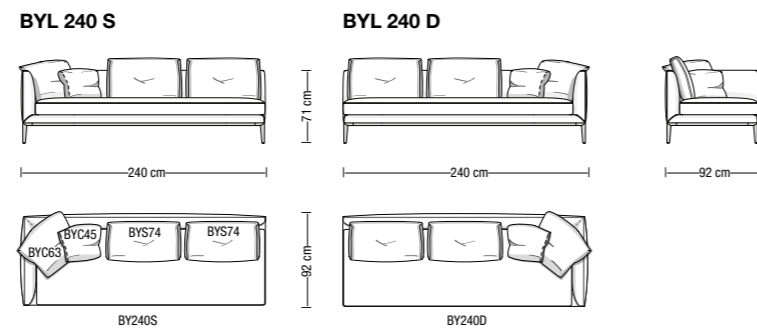
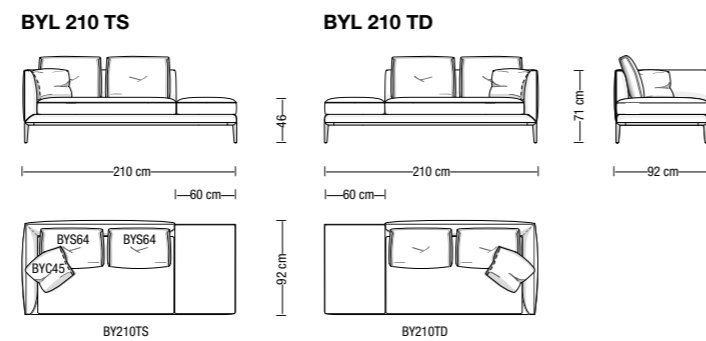
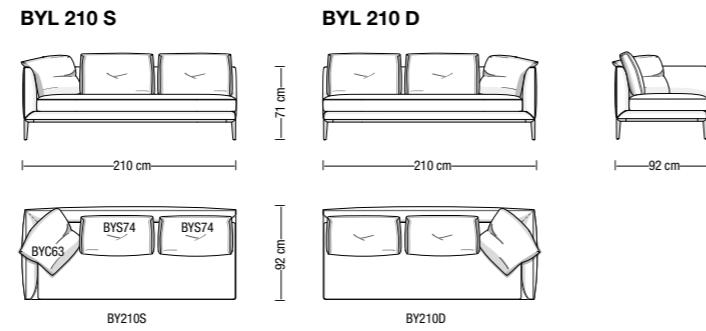
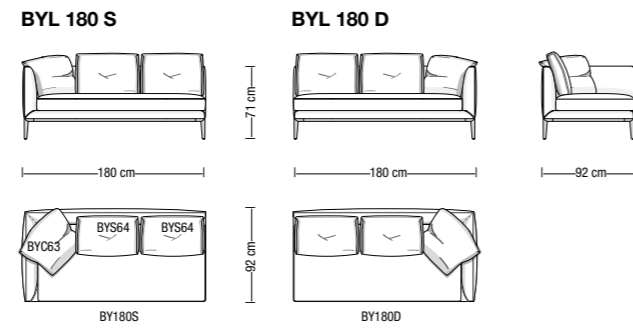

Terminali / angolari, profondità 92 cm
Terminal corner elements, 92 cm depth

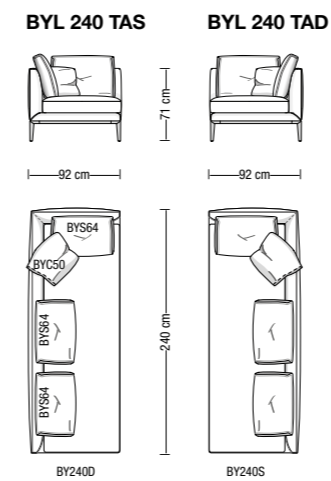
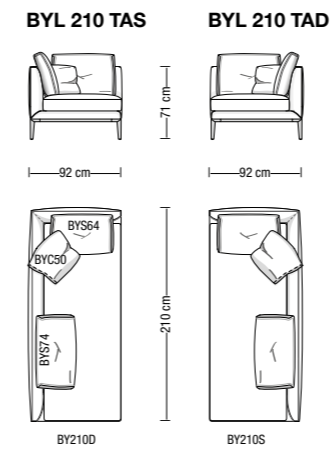
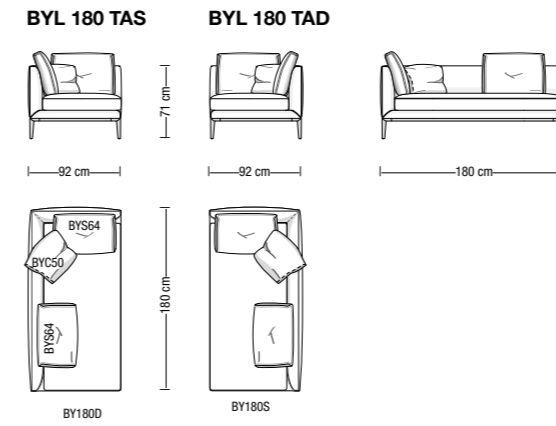

Terminali con penisola, profondità 92 cm
Open-end terminal elements, 92 cm depth

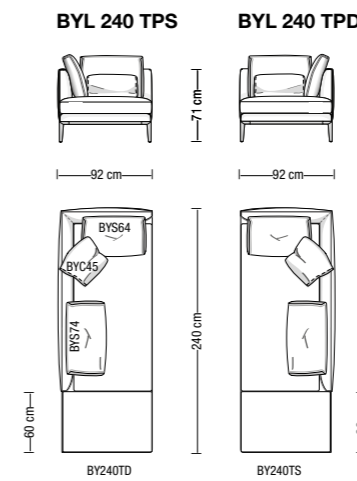
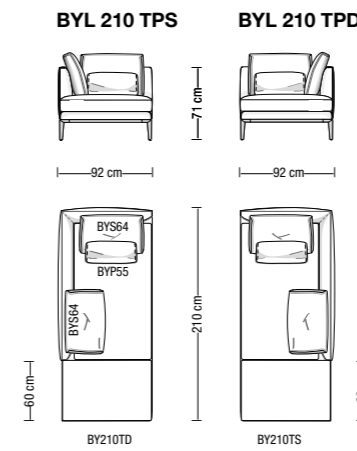

Terminali / angolari, profondità 92 cm
Terminal corner elements, 92 cm depth

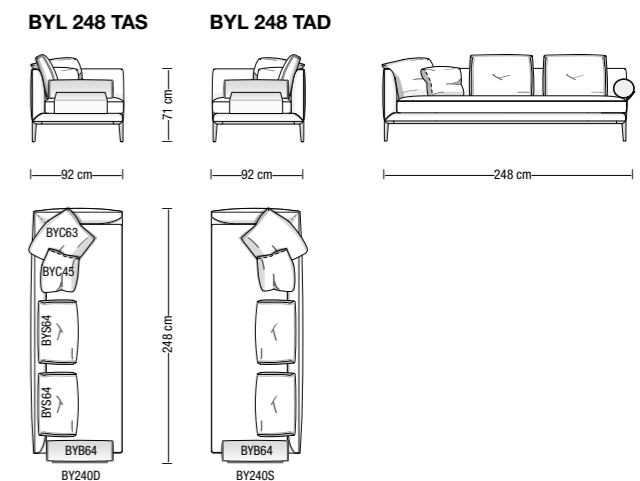
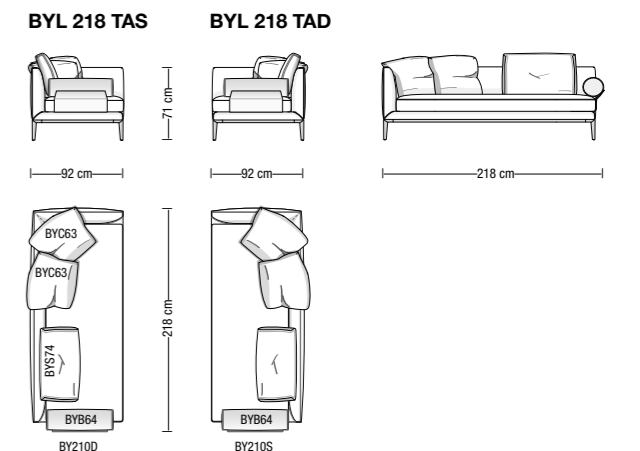
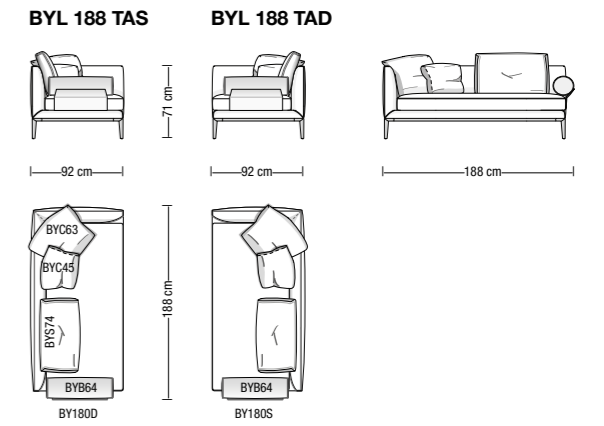

Chaise-longues
Chaise-longue

BYL 100X160 CLS **BYL 100X160 CLD**

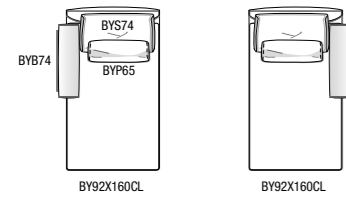
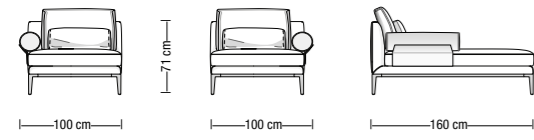

BYL 128X160 CLS **BYL 128X160 CLD**

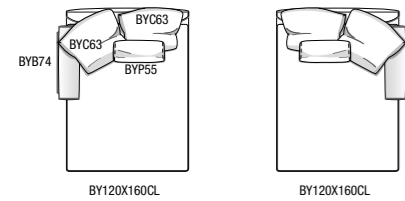
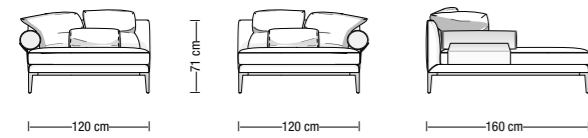

Pouf
Ottoman

BY 92X72 P

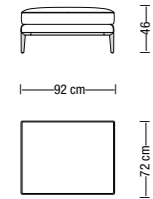

BY 92X92 P

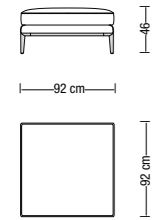

BY 165X92 P

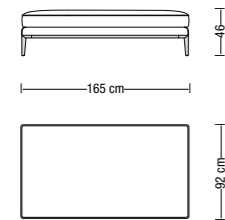

BY 58X48 P

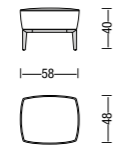

Braccioli mobili con rullo
Movable armrests with bolster

BYB 74

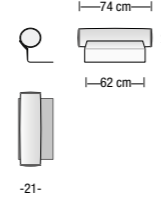

BYB 64

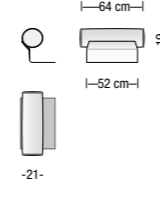

L'inserimento dei braccioli mobili nelle basi divano, aumenta la larghezza di 8 cm
Addition of movable armrests in sofa bases increases the width by 8 cm

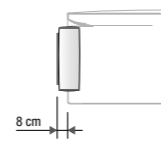

Cuscinerie
Cushions

BYS 54

Schienale da 54 cm
Backrest cushion 54 cm

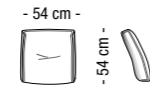

BYC 45

Cuscino 45x45 in piuma
Cushion 45x45 feather

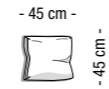

BYS 64

Schienale da 64 cm
Backrest cushion 64 cm

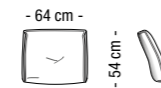

BYC 50

Cuscino 50x50 in piuma
Cushion 50x50 feather



BYS 74

Schienale da 74 cm
Backrest cushion 74 cm

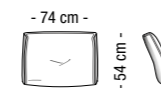

BYC 63

Cuscino 63x63 in piuma
Cushion 63x63 feather



BYS 54V

Poggiatesta da 54 cm
Vertical backrest cushion 54 cm

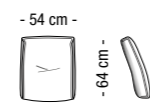

Da utilizzare in abbinata a BYSUP
To be used in combination with BYSUP

BYSUP

Schienale di supporto in metallo e pelle
Leather and steel backrest

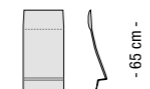

- 37 cm -

Da utilizzare in abbinata a BYS54V
To be used in combination with BYS54V

BYP 55

Poggiatesta da 55 cm
lumbar rest 55 cm

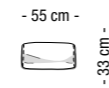

BYP 65

Poggiatesta da 65 cm
lumbar rest 65 cm



Divani con braccioli a rullo, profondità 102 cm
Sofas with roll armrests, 102 cm depth

BYL 181 X

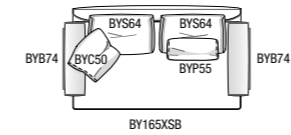
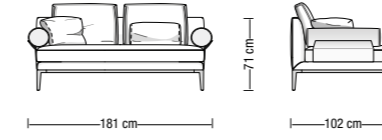

BYL 211 X

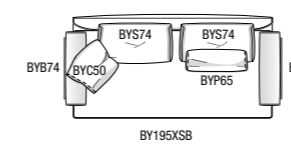
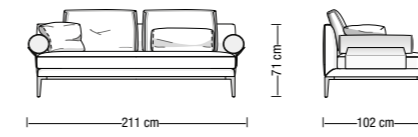

BYL 241 X

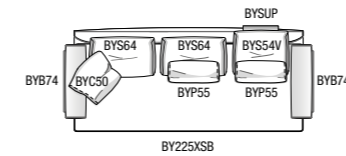

Disposizione alternativa schienali
Alternative backrest cushions layout

BYL 241 X -2

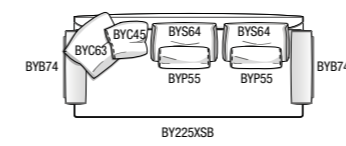
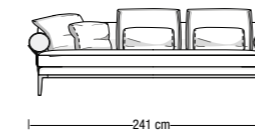

Divani con 1 bracciolo a rullo, profondità 102 cm
Sofas with 1 roll armrest, 102 cm depth

BYL 173 X S

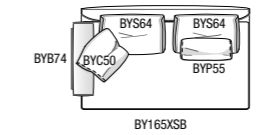
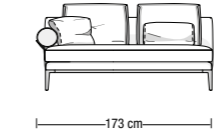

BYL 173 X D

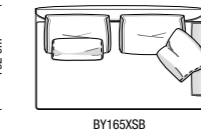
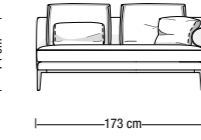

BYL 203 X S

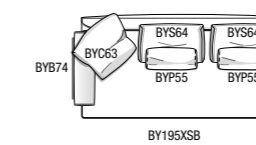
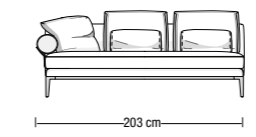

BYL 203 X D

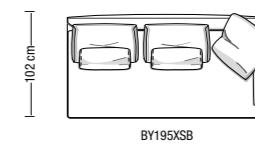
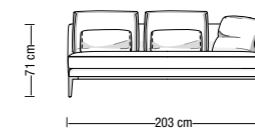

BYL 233 X S

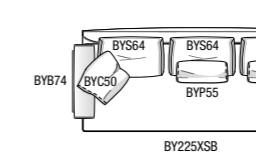
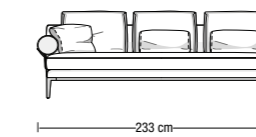

BYL 233 X D

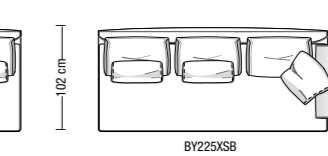
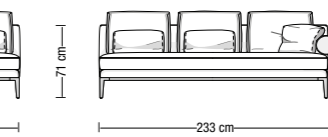

Divani centrali, profondità 102 cm
Central elements, 102 cm depth

BYL 165 X SB

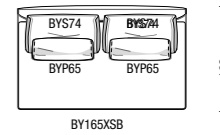
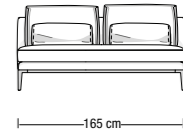

BYL 195 X SB

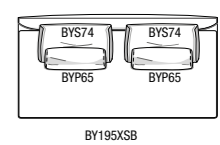
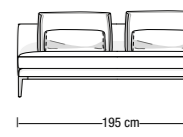

BYL 225 X SB

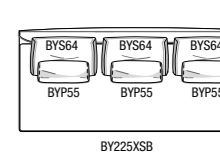
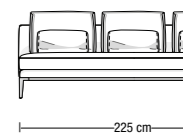

Divani con braccioli, profondità 102 cm
Sofas with armrests, 102 cm depth

BYL 195 X

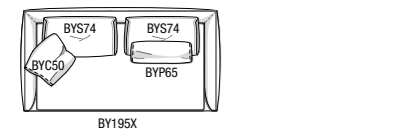
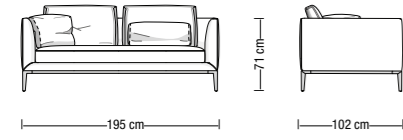

BYL 225 X

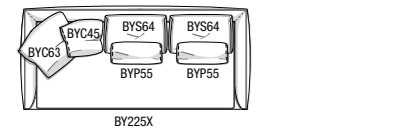
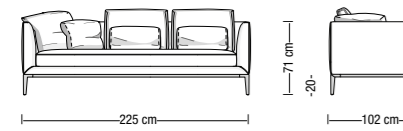

BYL 255 X

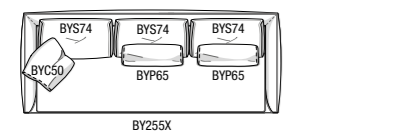
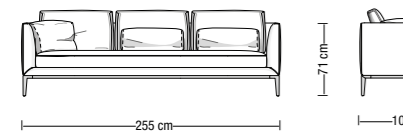

Disposizione alternativa schienali
Alternative backrest cushions layout

BYL 255 X -2

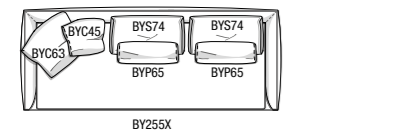
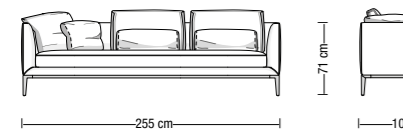

Divani con 1 bracciolo, profondità 102 cm
Sofas with 1 armrest, 102 cm depth

BYL 180 X S

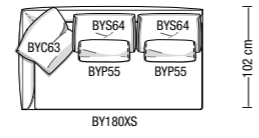
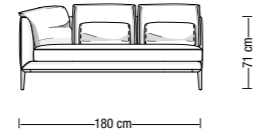

BYL 180 X D

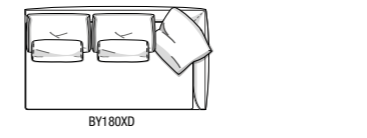
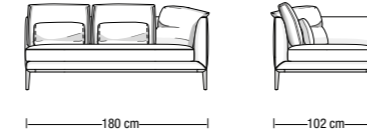

BYL 210 X S

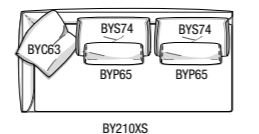
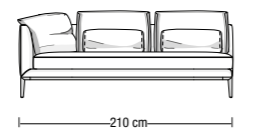

BYL 210 X D

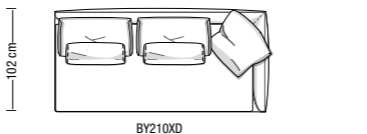
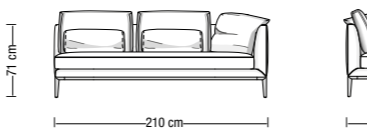

BYL 210 X TS

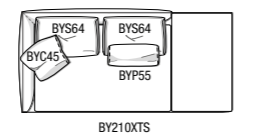
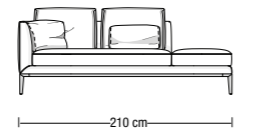

BYL 210 X TD

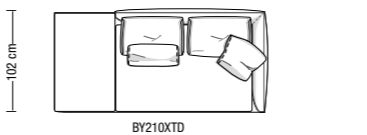
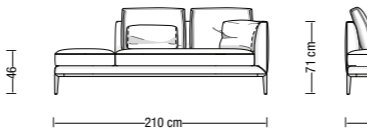

BYL 240 X S

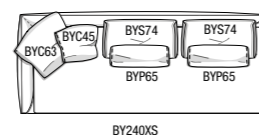
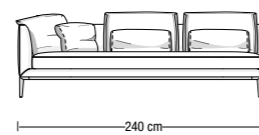

BYL 240 X D

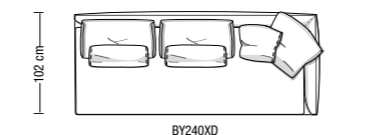
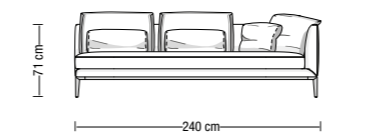

BYL 240 X TS

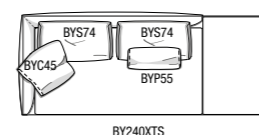
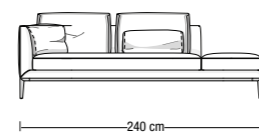

BYL 240 X TD

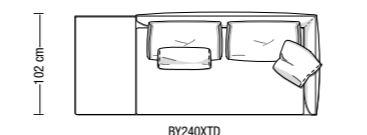
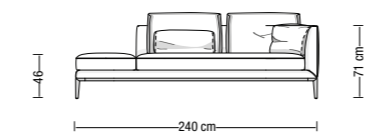

Terminali / angolari, profondità 102 cm
Terminal corner elements, 102 cm depth

BYL 180 X TAS

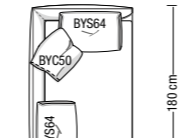
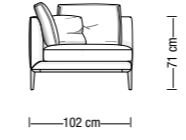

BYL180XTAD

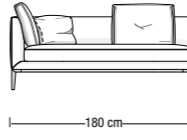
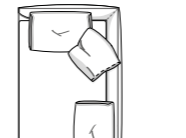
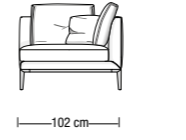

BYL 210 X TAS

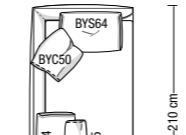
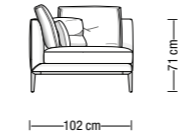

BYL 210 X TAD

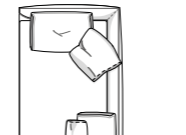
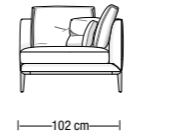

Terminali con penisola, profondità 102 cm
Open-end terminal elements, 102 cm depth

BYL 210 X TPS

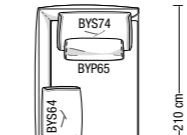
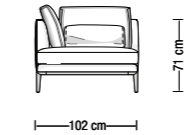

BYL 210 X TPD

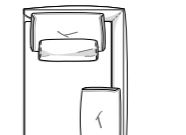
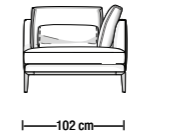

Terminali / angolari, profondità 102 cm
Terminal corner elements, 102 cm depth

BYL 188 X TAS

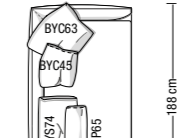
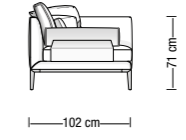

BYL 188 X TAD

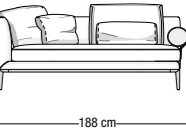
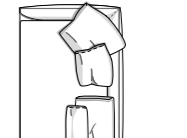
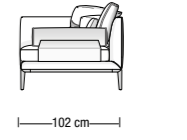

BYL 218 X TAS

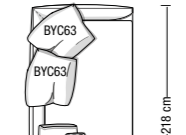
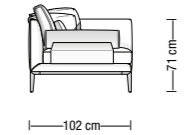

BYL 218 X TAD

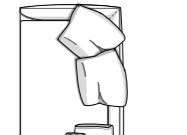
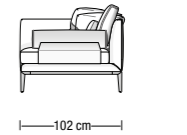

BYL 240 X TAS

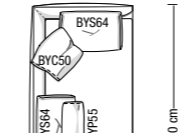
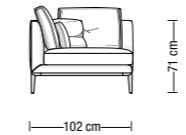

BYL 240 X TAD

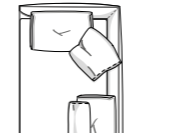
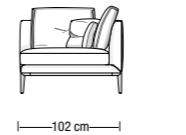

BYL 240 X TPS

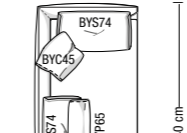
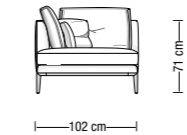

BYL 240 X TPD

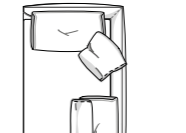
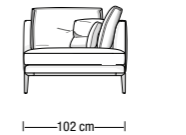

BYL 248 X TAS

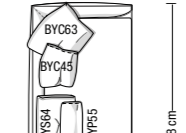
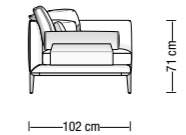

BYL 248 X TAD

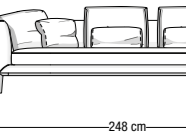
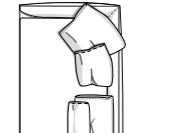
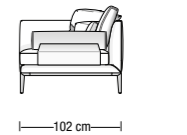

Chaise-longues
Chaise-longue

BYL 100X160 CLS **BYL 100X160 CLD**

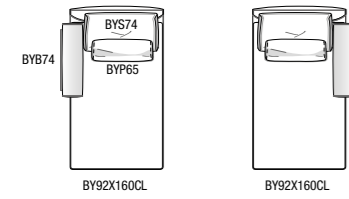
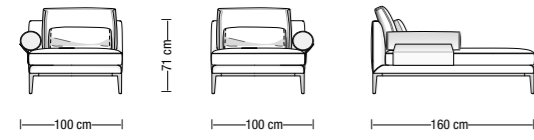

BYL 128X160 CLS **BYL 128X160 CLD**

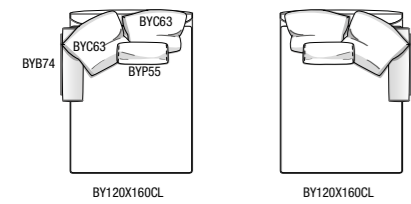
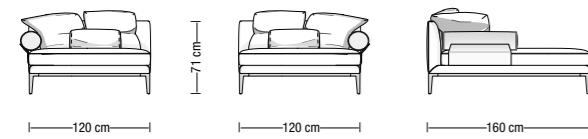

Pouf
Ottoman

BY 92X72 P

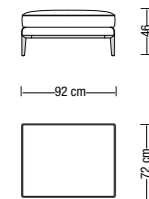

BY 58X48 P

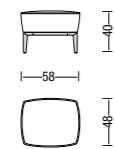

BY 92X92 P

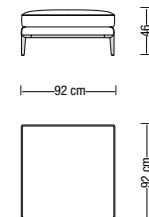

BY 165X92 P

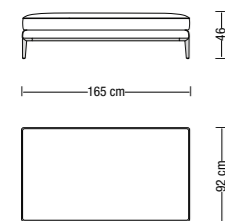

Braccioli mobili con rullo
Movable armrests with bolster

BYB 74

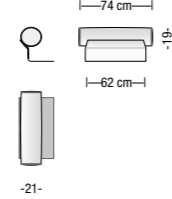

BYB 64

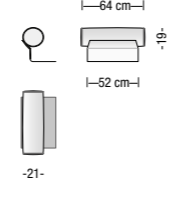

L'inserimento dei braccioli mobili nelle basi divano, aumenta la larghezza di 8 cm
Addition of movable armrests in sofa bases increases the width by 8 cm

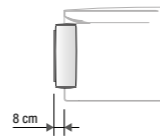

Cuscinerie
Cushions

BYS 54

Schienale da 54 cm
Backrest cushion 54 cm

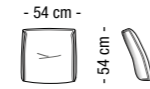

BYC 45

Cuscino 45x45 in piuma
Cushion 45x45 feather

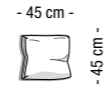

BYS 64

Schienale da 64 cm
Backrest cushion 64 cm

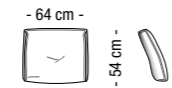

BYC 50

Cuscino 50x50 in piuma
Cushion 50x50 feather



BYS 74

Schienale da 74 cm
Backrest cushion 74 cm

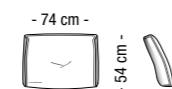

BYC 63

Cuscino 63x63 in piuma
Cushion 63x63 feather



BYS 54V

Schienale verticale da 54 cm
Vertical backrest cushion 54 cm

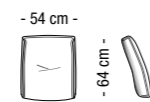

BYP 55

Poggiareni da 55 cm
lumbar rest 55 cm

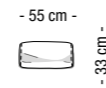

Da utilizzare in abbinata a BYSUP
To be used in combination with BYSUP

BYSUP

Schienale di supporto in metallo e pelle
Leather and steel backrest

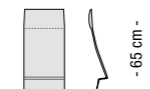

- 37 cm -

Da utilizzare in abbinata a BYSS4V
To be used in combination with BYSS4V

BYP 65

Poggiareni da 65 cm
lumbar rest 65 cm



Composizioni suggerite
Suggested Compositions

BY 1

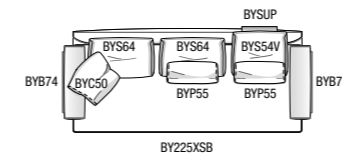
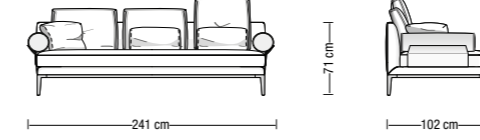

BY 3

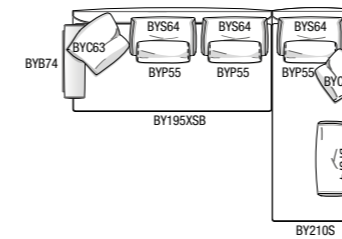
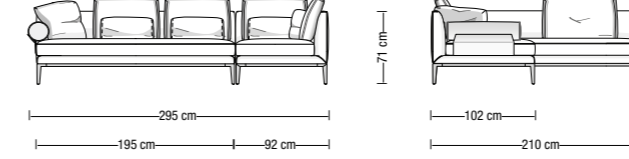

BY 5

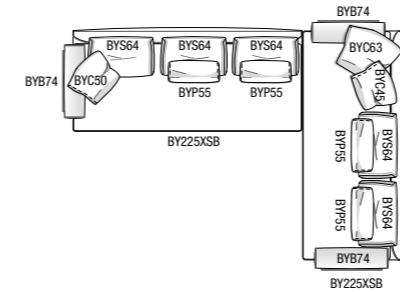
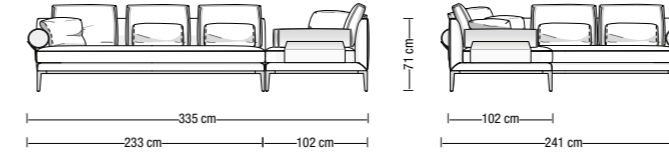

BY 2

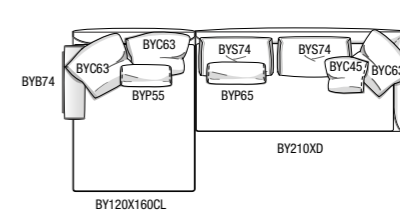
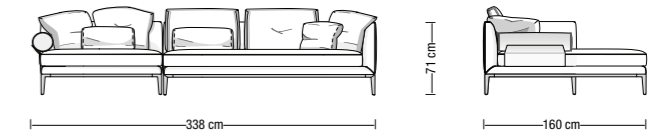

BY 4

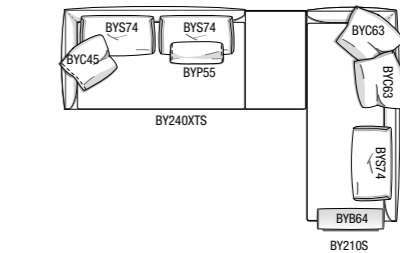
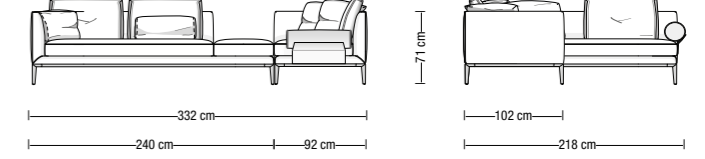

BY 6

