



**PRESS RELEASE  
PALETTE TABLE**

2015



# &TRADITION

LAUNCHES

## PALETTE TABLE

BY JAIME HAYON

&TRADITION LAUNCHES THE PALETTE TABLES. A SERIES OF THREE MULTI-TIERED TABLES MIXING MARBLE, ASH VENEER, BRASS AND SATIN BRUSHED STAINLESS STEEL DESIGNED BY JAIME HAYON.

2015

Recalling inspiration from Alexander Calder's kinetic sculptures, Spanish artist / designer Jaime Hayon creates a harmonious composite of disparate sizes, shapes, colours and materials which elegantly come together in a cohesive design.

"I've been fascinated by Alexander Calder for ages," admits Hayon. "He was the originator of the mobile. While everyone was drawing on paper, Calder transformed abstract drawings into 3D linear sculptures. With the Hayon Lounge Tables, you get a similar sense of equilibrium from any angle. A feeling of motion in a static object, merging the elegance of marble with the strength of metal and the lightness of wood."

Each table beautifully balances different shapes at varying heights which form a unified whole. Featuring a painter's palette shape, a circle, a rounded rectangle, an elongated oval and a hexagon. Hayon expertly orchestrates each collage of sizes and shapes.

Adding even more appeal is a compelling mix of materials. Including marble, such as polished Nero Marquina, Rosso Levanto and honed Bianco Carrara. Ash veneer makes its way in stained dark grey, blue or pale pink. Meanwhile steel as the armature keeping these diverse shapes affixed - almost in suspended animation.

As &tradition's Brand Director Martin Kornbek Hansen sees it, "I love Hayon's uncanny ability to mix and mismatch every design parameter into one holistic table that would welcome any coffee cup or cosy conversation. Achieved with Hayon's typical, playful approach to practicality - with plenty of personality.

Jaime Hayon is a Spanish artist / designer with offices in Italy, Spain and Japan. Known for his deep respect for artisan skills, finely-crafted details and a passion for play, Hayon is considered one of the most influential creators of our time, blurring the lines between art, decoration and design. A prolific designer always seeking new design horizons, his scope of work extends from furniture, lighting and home accessories to hotel and retail interiors, as well as ceramics, shoes and timepieces.

&tradition is a Danish design company established in 2010 with the founding principle being tradition tied to innovation. Our unique library of furniture and lighting spans from the 1930s to the present day and includes designs by internationally renowned designers.

<b>Product category</b>	Lounge table
<b>Production Process</b>	The base is made from welded and powder coated steel tubes. The table tops are made from laser cut satin polished stainless steel, honed marble and stained ash veneer.
<b>Materials</b>	Stainless steel, white Bianco Carrara marble, pink stained ash.
<b>Dimensions (cm/in)</b>	JH6 - H:46.7cm/18.4in, W:82.5cm/ 32.5in, D:70.8cm/ 27.8in. JH7 - H:47cm/ 18.5in W:115cm/45.3in, D:67.8/ 26.7in. JH8 - H:57cm/ 22.4in, W:66.3cm/ 26.1in, D:54.9cm/ 21.6in.
<b>Colors</b>	Stainless steel with white Bianco Carrara marble and pale pink stained ash.
<b>Design year</b>	2015
<b>Press info</b>	andtradition.com For image downloads go to andtradition.com / downloads For press releases go to andtradition.com / press For price requests please contact press@andtradition.com
<b>Please contact for more information</b>	PR & Communication manager Camilla Høeg Gade press@andtradition.com T +45 60 20 13 13



JH6

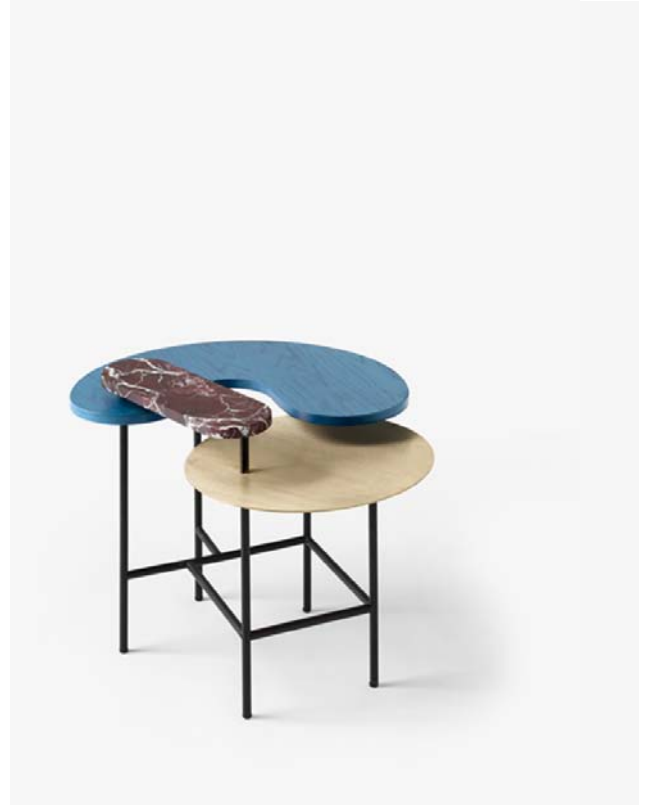

JH8



JH7



# PALETTE JH25

BY JAIME HAYON  
2018

# PALETTE JH25

BY JAIME HAYON

2018



What makes people drawn towards each other? It starts with setting the scene for an informal exchange. With the Palette lounge table by Jaime Hayon, the merging of diverse shapes, sizes, colours and materials is almost a metaphor for bringing different people together to connect – over a table that makes even large spaces feel more intimate.

Adding to the cohesive effect of the design is the choice of elegant materials, such as the option of walnut or black ash together with black marble and brass. A compelling mix of the warmth of wood, the natural pattern and regal appeal of marble and the satin polished brass. Materials that both contrast and compliment each other in a table that instantly signals exclusivity.

With the Palette series, Hayon has succeeded in creating a harmonious concept of connectivity – both in terms of the design and the opportunity for people to connect with each other. The lounge version expands this opportunity to an array of interiors where intimacy is everything.

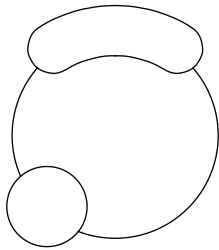

103cm / 40.6in

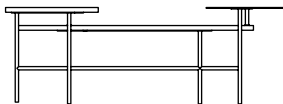

118cm / 46.5in

42cm / 16.5in

<b>Category</b>	Lounge table
<b>Production process</b>	The base is made from welded and powder coated steel tubes. The table tops are made from laser cut satin polished brass, polished marble and lacquered veneer.
<b>Environment</b>	Indoor
<b>Material</b>	Brass, Nero Marquina marble, lacquered ash veneer, lacquered walnut veneer
<b>Dimensions (cm/in)</b>	H: 42cm/16.5in, W: 118cm/46.5in, D: 103cm/40.6in
<b>Weight (kg)</b>	38 kg
<b>Colours</b>	Brass, Nero Marquina, black lacquered ash Brass, Nero Marquina, lacquered walnut
<b>Gliders</b>	The Palette tables are fitted with plastic gliders.
<b>Cleaning instructions</b>	Please download our material Care & Cleaning Instructions through <a href="http://www.andtradition.com">www.andtradition.com</a>
<b>Package dimensions (cm/in)</b>	H: 49cm/19.3in, D: 106cm/41.7in, L: 120cm/47.3in

**PRODUCT**



**COLOUR**



**Brass, Nero Marquina &  
black lacquered ash**



**Brass, Nero Marquina &  
lacquered walnut**



# PALETTE JH26

BY JAIME HAYON  
2018

# PALETTE JH26

BY JAIME HAYON

2018



The Palette side table is the perfect partner for any cosy corner, entrance, hallway or display area. Comprised of a curated mix of shapes, colours and materials that add a cohesive effect to any environment.

Referencing the kinetic sculptures of Alexander Calder, designer Jaime Hayon created a static expression of a design in motion. The outcome is a multi-tiered side table merging diverse elements into one design - crafted with exclusive materials. Choose from walnut or black ash coupled with black marble and you have an exquisite design for a sofa set-up in a private or commercial setting or in-shop display.

By combining various elements into one single entity, the Palette side table is like a 3D sculpture that's contemporary and compelling. With an uncanny ability to bring different elements in a space together in one unified look.

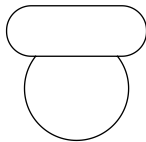

46cm / 18.1in

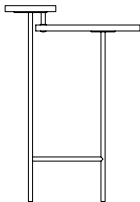

47cm / 18.5in

67cm / 26.4in

<b>Category</b>	Side table
<b>Production process</b>	The base is made from welded and powder coated steel tubes. The table tops are made from polished marble and lacquered veneer.
<b>Environment</b>	Indoor
<b>Material</b>	Nero Marquina marble, lacquered ash veneer, lacquered walnut veneer
<b>Dimensions (cm/in)</b>	H: 67cm/26.4in, W: 47cm/18.5in, D: 46cm/18.1in
<b>Weight (kg)</b>	10 kg
<b>Colours</b>	Nero Marquina, black lacquered ash Nero Marquina, lacquered walnut
<b>Gliders</b>	The Palette tables are fitted with plastic gliders.
<b>Cleaning instructions</b>	Please download our material Care & Cleaning Instructions through <a href="http://www.andtradition.com">www.andtradition.com</a>
<b>Package dimensions (cm/in)</b>	H: 70cm/27.6in, D: 48cm/18.9in, L: 50cm/19.7in



**PRODUCT**

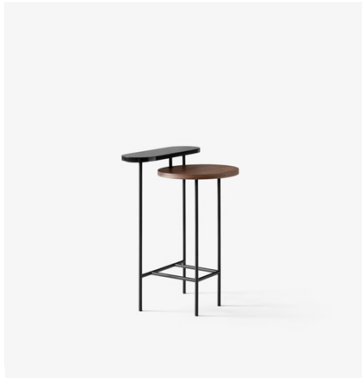

**COLOUR**



**Nero Marquina &  
black lacquered ash**



**Nero Marquina &  
lacquered walnut**



## PALETTE TABLE JH7, JH8, J25 & JH26

BY JAIME HAYON  
2015

Congratulations on choosing this original Palette table designed by Jaime Hayon. We hope you will enjoy using this product and follow these instructions to ensure correct assembly. If you have any questions or comments, please do not hesitate to contact us by mail on:

[info@andtradition.com](mailto:info@andtradition.com)

## SAFETY PRECAUTIONS

- Dispose of any plastic bags and foam from packaging and do not allow children to play with it.
- The table is only intended for interior use.
- Handle brass/marble table top with care as brass may bend and get scratched, where as marble may break. Please note that marble is very heavy.
- Spilled liquids of any kind should be removed immediately from the table top as it may penetrate the surface treatment and cause damage to it.

## CLEANING INSTRUCTIONS

The Palette table is made from powder coated steel, ash or walnut veneer, polished marble and brushed brass. Never use aggressive or abrasive cleaning detergents for any parts of the table, as this will cause irreparable damage.

### Wooden table top

Dust table top with a soft cloth. Clean table top with a soft cloth wrung in a solution of water and universal cleaning detergent following the wood grains and dry immediately with a soft cloth, again following the wood grains. Avoid use of abrasive cleaning products such as steel wool or polish. Avoid placing lacquered and stained wood in excessive humidity or heat.

### Marble plate

The marble plate is made from natural marble and will therefore have variations in structure and colour. This should not be considered a defect nor a valid reason for claims. The marble is treated with sealer, but it is strongly recommended to use a trivet and never place glasses or cups with liquids directly on to the marble. Spilled liquids will leave permanent stains due to the natural sensitivity of marble. For daily cleaning of the marble top it is recommended to use a cleaning agent specifically developed for stone or marble. It is also highly recommended to do a re-sealing of the marble every second month, using an appropriate sealer developed specifically for stone or marble.

### Brass plate

The brass plate is a alloy of copper and zinc, with a very fine grid brushed surface, and coating of Renaissance Wax. The Renaissance Wax provides a barrier to slow ageing and oxidation, but over time the table will develop a unique and beautiful patina, this is a natural and beautiful part of

the life of the brass product.

Handling and use of the table will over time penetrate the protective wax barrier, and the oils in our skin will then cause the table to oxidise more quickly highlighting fingerprints and other wear.

To maintain the wax barrier over time, we recommend occasionally reapplying Renaissance Wax.

Being brass and therefore a natural product, the plate is still sensitive to liquids and it is strongly recommended to use a trivet and never place glasses or cups with liquids directly on to the brass plate. Spilled liquids may leave permanent stains.

To ensure the brass will look beautiful for years to come, please brush the brass plates with a fine grit abrasive brushing pad such as a the 3M Scotch-Brite™ Hand Pad 7447. It is very important to always wipe in the direction of the grain of the brushed surface.

After brushing, use a non-aggressive, multipurpose cleaning solvent such as CT1 Multi-Solve, to degrease the product. Apply this with a clean soft cloth following the grain direction.

Once the brass has been cleaned, reapply Renaissance Wax to the entire surface, following the manufacturer's instructions, again in the direction of the grain of the brushed surface.

Do NOT use ammonia, products containing ammonia, or any other corrosive cleaning solutions as this can damage the brass.



## PALETTE TABLE JH6

BY JAIME HAYON  
2015

# PALETTE TABLE JH6

BY JAIME HAYON  
2015



“Tables are where people exchange ideas, express emotions and connect with each other,” explains Spanish artist / designer Jaime Hayon. “As a multi-purpose object, why not design a multi-tiered table where different sizes, shapes, colours and materials converge together? Like one of Alexander Calder’s kinetic sculptures. Various shapes suspended in air but kept in place, supported by a metal armature. Creating a curious equilibrium that resembles a mobile - only static.”

At first glance, each Hayon Lounge table is a lesson in geometry. One version features a round shape coupled with a hexagon together with an elongated oval. Another version has a painter’s palette shape, while another version juxtaposes a rounded rectangle with an elongated oval and a circle. Each table is a composition of three distinctive shapes beautifully balanced at different heights which form a unified whole.

“The Hayon Lounge Table is my idea of interesting,” remarks &tradition’s Brand Director Martin Kornbek Hansen. “The polished marble brings a sense of nobility, while the oak adds earthiness. With metal as the stabilising factor connecting different shapes, colours and materials together. With each table offering three surfaces to choose from, it’s a modern answer to our multi-tasking lives.”

Varying in length from 67 cm to 83 cm to 116 cm, the Hayon Lounge Tables give a linear feeling to a 3D object. A sculpture you can enjoy looking at and living with.

D: 82.5cm / 32.5in

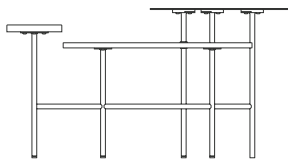

H: 46.7cm / 18.4in

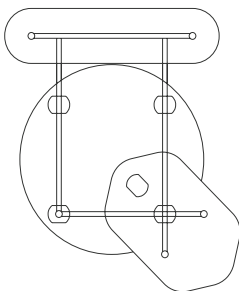

W: 70.8cm / 27.9in

<b>Product type</b>	Lounge table.
<b>Production Process</b>	The base is made from welded and powder coated steel tubes. The table tops are made from laser cut satin polished brass, polished marble and stained ash veneer.
<b>Environment</b>	Indoor.
<b>Dimensions ( cm / in )</b>	D: 82.5cm/ 32.5in, W: 70.8cm/ 27.9in, H: 46.7cm/ 18.4in
<b>Weight ( kg )</b>	16.0kg.
<b>Materials</b>	Stainless steel, white Bianco Carrara marble, pale pink stained ash.
<b>Colours</b>	Pink stained ash.
<b>Cleaning Instructions</b>	Please download our Material Care & Cleaning Instructions through <a href="http://www.andtradition.com">www.andtradition.com</a>
<b>Package Dimensions (cm / in)</b>	H: 47.0cm/18.5in x D: 71.0cm/28in x L: 83.0cm/32.7in



## PALETTE TABLE JH7

BY JAIME HAYON  
2015



# PALETTE TABLE JH7

BY JAIME HAYON  
2015

“Tables are where people exchange ideas, express emotions and connect with each other,” explains Spanish artist / designer Jaime Hayon. “As a multi-purpose object, why not design a multi-tiered table where different sizes, shapes, colours and materials converge together? Like one of Alexander Calder’s kinetic sculptures. Various shapes suspended in air but kept in place, supported by a metal armature. Creating a curious equilibrium that resembles a mobile - only static.”

At first glance, each Hayon Lounge table is a lesson in geometry. One version features a round shape coupled with a hexagon together with an elongated oval. Another version has a painter’s palette shape, while another version juxtaposes a rounded rectangle with an elongated oval and a circle. Each table is a composition of three distinctive shapes beautifully balanced at different heights which form a unified whole.

“The Hayon Lounge Table is my idea of interesting,” remarks &tradition’s Brand Director Martin Kornbek Hansen. “The polished marble brings a sense of nobility, while the oak adds earthiness. With metal as the stabilising factor connecting different shapes, colours and materials together. With each table offering three surfaces to choose from, it’s a modern answer to our multi-tasking lives.”

Varying in length from 67 cm to 83 cm to 116 cm, the Hayon Lounge Tables give a linear feeling to a 3D object. A sculpture you can enjoy looking at and living with.

D: 115.2cm / 45.4in

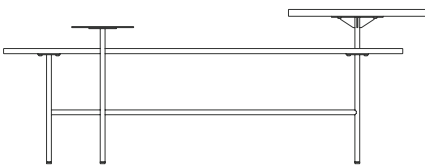

H: 47cm / 18.5in

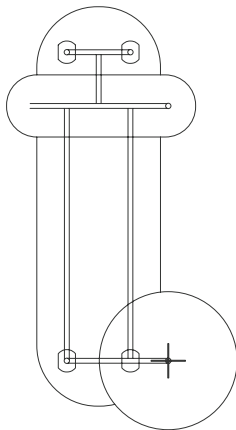

W: 67.8cm / 26.7in

<b>Product type</b>	Lounge table.
<b>Production Process</b>	The base is made from welded and powder coated steel tubes. The table tops are made from laser cut satin polished brass, polished marble and stained ash veneer.
<b>Environment</b>	Indoor.
<b>Dimensions ( cm / in )</b>	D: 115.2cm/ 45.4in, W: 67.8cm/ 26.7in, H: 47cm/ 18.5in
<b>Weight ( kg )</b>	19.0kg.
<b>Materials</b>	Brass, black Nero Marquina marble, black stained ash.
<b>Colours</b>	Black stained ash.
<b>Cleaning Instructions</b>	Please download our Material Care & Cleaning Instructions through <a href="http://www.andtradition.com">www.andtradition.com</a>
<b>Package Dimensions (cm / in)</b>	H: 47.0cm/18.5in x D: 68.0cm/26.8in x L: 116.0cm/45.7in.



# PALETTE TABLE JH8

BY JAIME HAYON  
2015





# PALETTE TABLE JH8

BY JAIME HAYON  
2015

“Tables are where people exchange ideas, express emotions and connect with each other,” explains Spanish artist / designer Jaime Hayon. “As a multi-purpose object, why not design a multi-tiered table where different sizes, shapes, colours and materials converge together? Like one of Alexander Calder’s kinetic sculptures. Various shapes suspended in air but kept in place, supported by a metal armature. Creating a curious equilibrium that resembles a mobile - only static.”

At first glance, each Hayon Lounge table is a lesson in geometry. One version features a round shape coupled with a hexagon together with an elongated oval. Another version has a painter’s palette shape, while another version juxtaposes a rounded rectangle with an elongated oval and a circle. Each table is a composition of three distinctive shapes beautifully balanced at different heights which form a unified whole.

“The Hayon Lounge Table is my idea of interesting,” remarks &tradition’s Brand Director Martin Kornbek Hansen. “The polished marble brings a sense of nobility, while the oak adds earthiness. With metal as the stabilising factor connecting different shapes, colours and materials together. With each table offering three surfaces to choose from, it’s a modern answer to our multi-tasking lives.”

Varying in length from 67 cm to 83 cm to 116 cm, the Hayon Lounge Tables give a linear feeling to a 3D object. A sculpture you can enjoy looking at and living with.

D: 66.3cm / 26.in

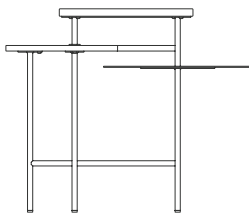

H: 57 cm / 22.4in

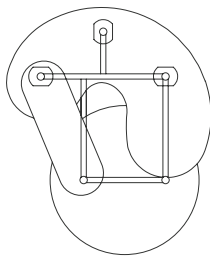

W: 54.9cm / 21.6in

<b>Product type</b>	Lounge table.
<b>Production Process</b>	The base is made from welded and powder coated steel tubes. The table tops are made from laser cut satin polished brass, polished marble and stained ash veneer.
<b>Environment</b>	Indoor.
<b>Dimensions ( cm / in )</b>	D: 66.3cm / 26.in, W:54.9cm / 21.6in, H: 57 cm / 22.4in
<b>Weight ( kg )</b>	12.0kg.
<b>Materials</b>	Brass, red Rosso Levanto marble, blue stained ash.
<b>Colours</b>	Blue stained ash.
<b>Cleaning Instructions</b>	Please download our Material Care & Cleaning Instructions through <a href="http://www.andtradition.com">www.andtradition.com</a>
<b>Package Dimensions (cm / in)</b>	H: 57.0cm/22.5in x D: 55.0cm/21.7in x L: 67.0cm/26.4in.



# PALETTE JH8

BY JAIME HAYON  
2015

# PALETTE JH8

BY JAIME HAYON

2015



What makes people drawn towards each other? It starts with setting the scene for an informal exchange. With the Palette lounge table by Jaime Hayon, the merging of diverse shapes, sizes, colours and materials is almost a metaphor for bringing different people together to connect – over a table that makes even large spaces feel more intimate.

Adding to the cohesive effect of the design is the choice of elegant materials, such as the option of walnut or black ash together with black marble and brass. A compelling mix of the warmth of wood, the natural pattern and regal appeal of marble and the satin polished brass. Materials that both contrast and compliment each other in a table that instantly signals exclusivity.

With the Palette series, Hayon has succeeded in creating a harmonious concept of connectivity – both in terms of the design and the opportunity for people to connect with each other. The lounge version expands this opportunity to an array of interiors where intimacy is everything.

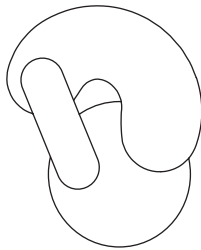

54.9cm / 21.6in

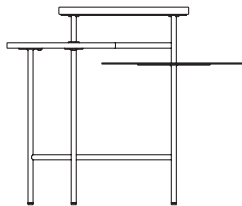

66.3cm / 26in

57cm / 22.4 in

<b>Category</b>	Lounge table
<b>Production process</b>	The base is made from welded and powder coated steel tubes. The table tops are made from laser cut satin polished brass, polished marble and lacquered veneer.
<b>Environment</b>	Indoor
<b>Material</b>	Brass, Rosso Levanto marble, lacquered ash veneer, Nero Marquina marble, lacquered walnut veneer
<b>Dimensions (cm/in)</b>	H: 57cm/22.4in, W: 54.9cm/21.6in, D: 66.3cm/26in
<b>Weight (kg)</b>	16 kg
<b>Colours</b>	Brass, Rosso Levanto marble, blue lacquered ash Brass, Nero Marquina marble, lacquered walnut
<b>Gliders</b>	The Palette tables are fitted with plastic gliders.
<b>Cleaning instructions</b>	Please download our material Care & Cleaning Instructions through <a href="http://www.andtradition.com">www.andtradition.com</a>
<b>Package dimensions (cm/in)</b>	H: 60cm/23.6in, D: 58cm/22.8in, L: 70cm/27.6in

**PRODUCT**



**COLOUR**

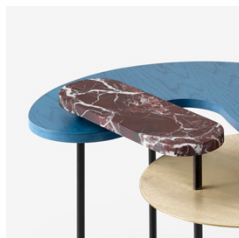

**Rosso Levanto marble,  
blue lacquered ash & brass**

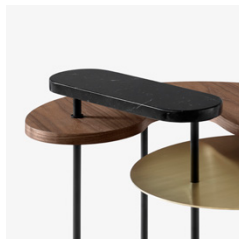

**Nero Marquina marble,  
lacquered walnut & brass**



# PALETTE JH9

BY JAIME HAYON  
2015



# PALETTE JH9

BY JAIME HAYON  
2015

“In a world where everyone is rushing around mega multi-tasking, to sit at an ordinary desk feels so static,” says Spanish artist / designer Jaime Hayon. “I felt compelled to design a desk with a feeling of motion, inspired by the kinetic sculptures of Alexander Calder. Balancing various shapes and materials at various heights supported by a metal frame. In theory it’s like a mobile but in reality it’s a desk.”

Each Palette desk partners two shapes together: an elongated bean shape with a simple round shape. Adding to the cohesive effect of the design is the choice of elegant materials, such as the option of walnut or black ash together with black marble and brass. A compelling mix of the warmth of wood, the natural pattern and regal appeal of marble and the satin polished brass. Materials that both contrast and compliment each other in a table that instantly signals exclusivity.

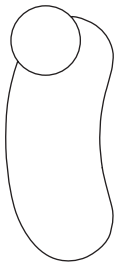

62cm / 24.4in

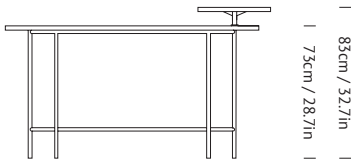

146cm / 57.5in

83cm / 32.7in  
73cm / 28.7in

<b>Category</b>	Desk
<b>Production process</b>	The base is made from welded and powder coated steel tubes. The table tops are made from laser cut satin polished brass, polished marble and lacquered veneer.
<b>Environment</b>	Indoor
<b>Material</b>	Brass, Nero Marquina marble, lacquered ash veneer, lacquered walnut veneer
<b>Dimensions (cm/in)</b>	H: 73-83cm/28.7-32.7in, W: 146cm/57.5in, D: 62cm/24.4in
<b>Weight (kg)</b>	22 kg
<b>Colours</b>	Nero Marquina marble, black lacquered ash Brass, grey green lacquered ash Brass, lacquered walnut
<b>Gliders</b>	The Palette tables are fitted with plastic gliders.
<b>Cleaning instructions</b>	Please download our material Care & Cleaning Instructions through <a href="http://www.andtradition.com">www.andtradition.com</a>
<b>Package dimensions (cm/in)</b>	H: 88cm/34.6in, D: 145cm/57in, L: 67cm/26.4in

**PRODUCT**



**COLOUR**



**Black lacquered ash &  
Nero Marquina marble**

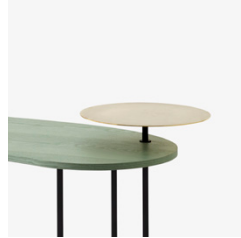

**Grey green lacquered ash  
& brass**

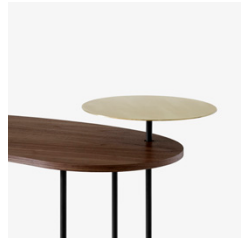

**Lacquered walnut  
& brass**



# PALETTE DESK JH9

BY JAIME HAYON  
2016



# PALETTE DESK JH9

BY JAIME HAYON  
2016



“In a world where everyone is rushing around mega multi-tasking, to sit at an ordinary desk feels so static,” says Spanish artist / designer Jaime Hayon. “I felt compelled to design a desk with a feeling of motion, inspired by the kinetic sculptures of Alexander Calder. Balancing various shapes and materials at various heights supported by a metal frame. In theory it’s like a mobile but in reality it’s a desk.”

Each Palette Desk partners two shapes together: an elongated bean shape with a simple round shape. The two merge a marvellous mix of regal materials available in three different combinations. For the table tops, choose from polished Nero Marquina marble or honed Bianco Carrara marble, satin polished brass or stained ash veneer in black, red or grey-green. The base is made from welded and powder coated steel tubes, adding a contemporary touch to this collage of contrasts.

“While most designers define themselves by one signature style, Hayon never ceases to surprise us with his amazing way of creating hybrid concepts as part of a new design idiom. With the Palette Desk, to be able to combine such disparate components into something so striking yet harmonious makes Hayon himself the master multi-tasker.”

The Palette Desk is almost like a multi-tiered sculpture that doubles as a desk.

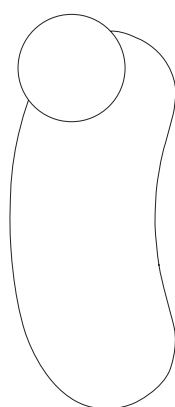
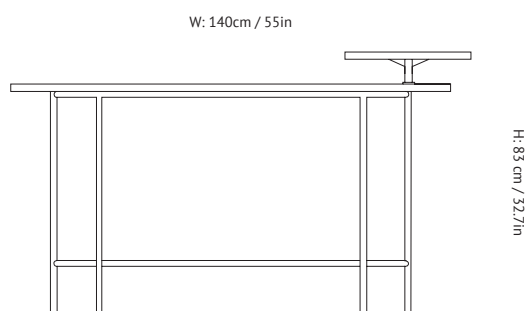

D: 62cm / 24.4in

<b>Product type</b>	Desk
<b>Production Process</b>	The base is made from welded and powder coated steel tubes. The table tops are made from marble or brass and stained ash veneer.
<b>Environment</b>	Indoor.
<b>Dimensions ( cm / in )</b>	H: 83cm/32.7in x D: 62.0cm/24.4in x L: 140cm/55in
<b>Weight ( kg )</b>	22kg.
<b>Materials</b>	Powder coated steel, marble or brass, stained ash veneer.
<b>Colours</b>	Polished black Nero Marquina marble, black stained ash veneer. Honed white Bianco Carrara marble, red stained ash veneer. Satin polished brass, grey-green stained ash veneer.
<b>Cleaning Instructions</b>	Please download our Material Care & Cleaning Instructions through <a href="http://www.andtradition.com">www.andtradition.com</a>
<b>Package Dimensions ( cm / in )</b>	H: 83.0cm/32.7in x D: 62.0cm/24.4in x L: 146.0cm/57.5in



JH9

JH9



JH9